

Linear Measuring Technology

Draw wire mechanics with analogue sensor

**Draw wire encoder A40, 1 m
Draw wire encoder A41, 2 m**

**Measuring length max. 2 m
Traverse speed max. 1 m/s**

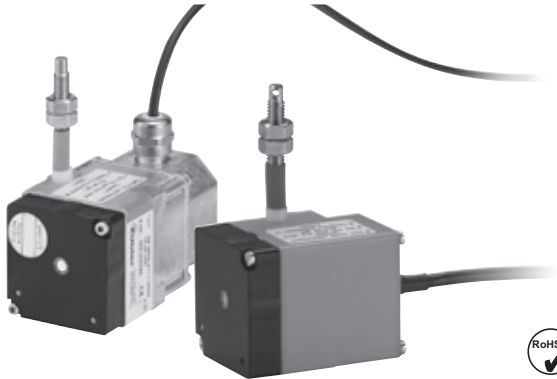

The draw wire encoders A40 and A41 with analogue output is characterised by its compact design. They are available with a potentiometer, voltage or current output.

Compact and simple

- Measuring length up to 2000 mm
- For applications with a low traversing speed
- Easy to install

Order code **D5.350X . AXX . 0000**
draw wire encoder

Type **a** **b** **c**

a Measuring range

- 1 = 1000 mm
- 2 = 2000 mm

b Output circuit

- 11 = analogue output 4 ... 20 mA
- 22 = analogue output 0 ... 10 V DC power supply 15 ... 28 V DC
- 33 = potentiometer output 10 kΩ

c Type of connection

- 1 = cable 2 m [6.56'] for measuring range 1000 mm: axial for measuring range 2000 mm: radial
- 2 = M12 connector, 4-pin, radial (only available for measuring range 2000 mm)

Accessories for draw wire encoder

Order No.

Guide pulley

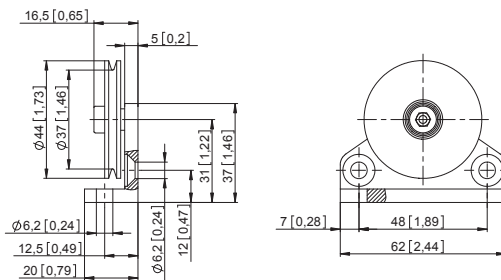

- Order code for the set:
- Guide pulley (anodised aluminium)
 - 2 x countersunk screws for lateral fixing
 - 2 x hexagonal screws for fixing on a flat surface

8.0000.7000.0045

Extension cable

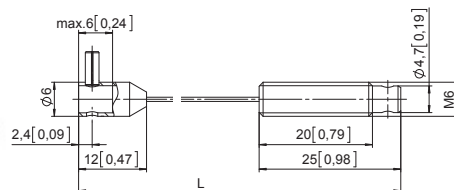

- Steel wire 2 m [6.56']
- Steel wire 5 m [16.40']
- Steel wire 10 m [32.81']
- Paraleine 2 m [6.56']

8.0000.7000.0033
8.0000.7000.0034
8.0000.7000.0035
8.0000.7000.0032

Linear Measuring Technology

Draw wire mechanics with analogue sensor	Draw wire encoder A40, 1 m Draw wire encoder A41, 2 m	Measuring length max. 2 m Traverse speed max. 1 m/s
---	--	--

Technical data

Mechanical characteristics (draw wire mechanics)		
Measuring range	1000 mm (A40)	2000 mm (A41)
Speed max.	0.8 m/s	1 m/s
Working temperature	0°C ... 50°C [+32°F ... +122°F]	-10°C ... +80°C [+14°F ... +176°F]
Protection	IP50	IP65
Weight	approx. 200 g [7.06 oz]	approx. 320 g [11.29 oz]
Extension force F_{min}	2 N	
Repeat accuracy	± 0.15 mm	
Linearity	± 0.35 %	
Material	housing plastic / zinc die cast	wire stainless-steel ø 0.45 mm plastic-coated

Electrical characteristics			
Analogue output	0 ... 10 V	4 ... 20 mA	Potentiometer 10 kΩ
Power supply	15 ... 28 V DC	–	–
Operating range	–	15 ... 28 V DC	max. 48 V DC
Temperature range	0°C ... 50°C [+32°F ... +122°F]	0°C ... 50°C [+32°F ... +122°F]	0°C ... 50°C [+32°F ... +122°F]
Load	max 500 Ω	max 500 Ω	–
CE compliant acc. to	EMC guideline 2004/108/EC		
RoHS guideline acc. to	guideline 2002/95/EC		

Terminal assignment

Colour	BN	WH	GN	GN
Pin M12	1	2	3	4
0 ... 10 V	+ 24 V DC	0 V	U_{out}	n.c.
0 ... 20 mA	I+	I-	n.c.	n.c.
Potentiometer	Po	Pe	S	n.c.

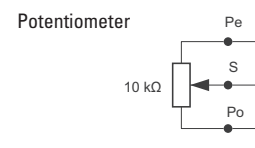
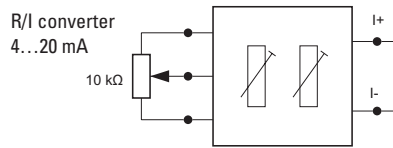
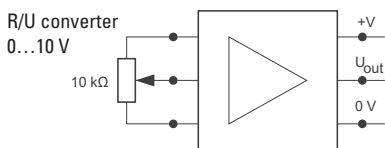

Dimensions

Dimensions in mm [inch]

for measuring range 1000 mm

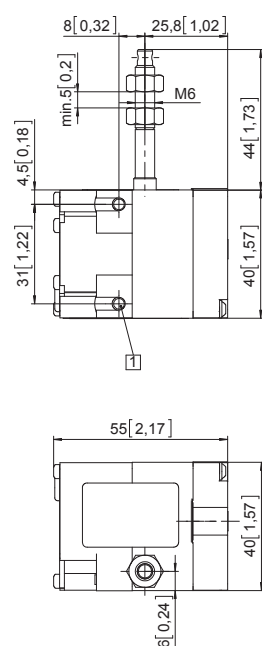

1 2 x M4, max. screw-in depth 8 mm [0.32"]

for measuring range 2000 mm

Cable connection

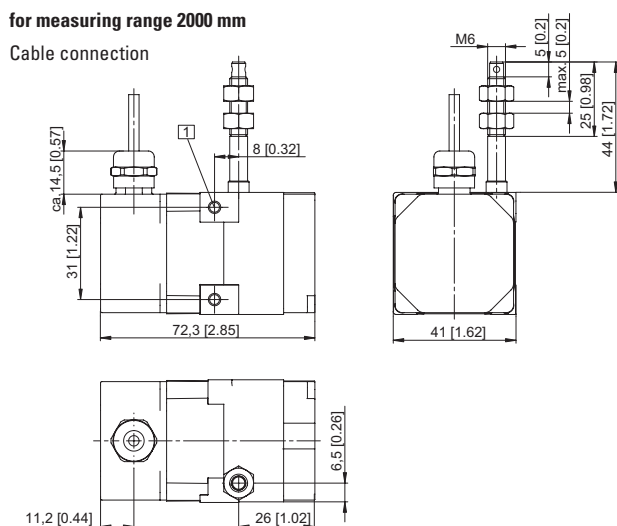

M12 connector

