

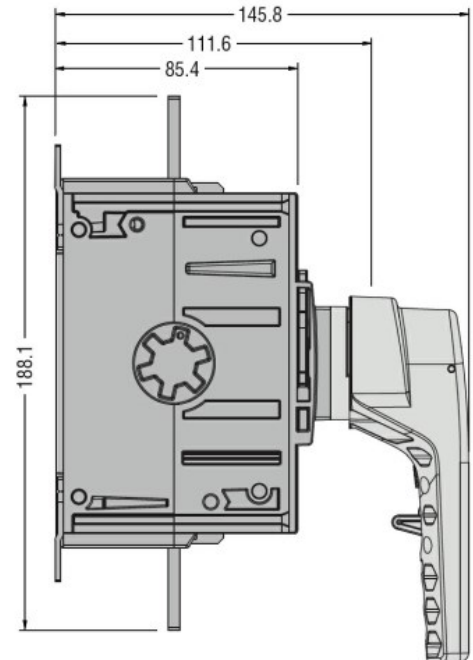

Product designation		Fourth pole
Product type designation		GLX42
Number of poles	Nr.	1
Operating voltage type		AC
Contact characteristics		
IEC Conventional free air thermal current I _{th}	A	500
Rated insulation voltage U _i IEC/EN	V	1000
Rated impulse withstand voltage U _{imp}	kV	12

Dimensions

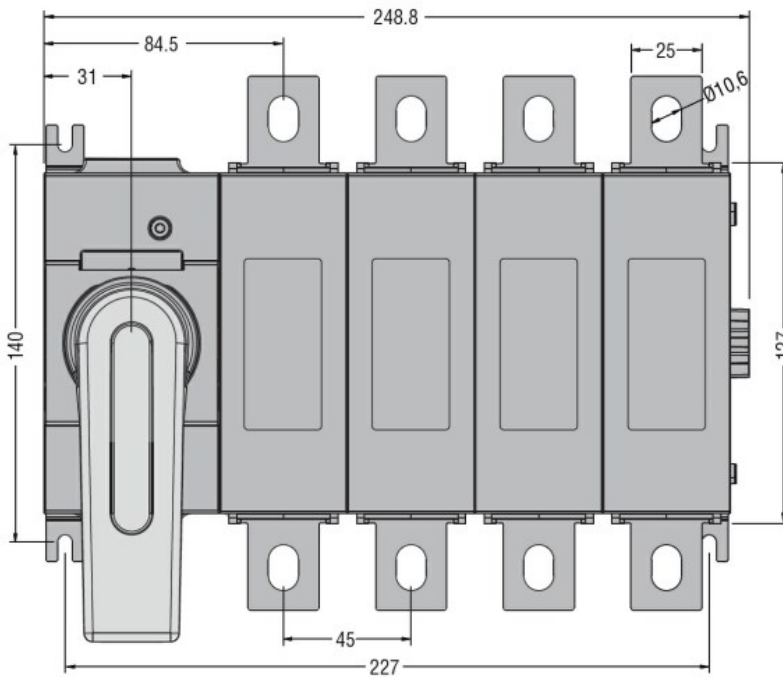

Wiring diagrams



Certifications and compliance

Compliance

IEC/EN 60947-1

IEC/EN 60947-3

ETIM classification

ETIM 8.0

EC002498 -
Accessories/spare
parts for low-
voltage switch
technology