

80 and 100 W - 10 Nm - Right-angle gearbox 801810 TNi20 - 0/10 V Part number Contact us



With or without integrated control electronics

- Output perpendicular to motor
- Ideal for short reduction ratios
- Ideal for very compact applications
- Silent operation
- Non-reversible movement at high ratios

Part numbers

Type	With built-in electronic control	Without built-in control, with Hall effect sensors	Ratios (i)	Output speed (rpm) 24 V DC	Available torque (Nm)
80181013	801810 TNi20 - 0/10 V TNi20	-	30	108	3,5

Specifications

General characteristics

Motor	801800
Nominal motor power at 24 V (W)	80
Speed control	0-10 V
Axial load dynamic (N)	100
Radial load dynamic (N)	150
Temperature rise at 50 % cycle (°C)	45
Weight (g)	1920
Protection index	IP54

Dimensions (mm)

801810 with built-in TNi20

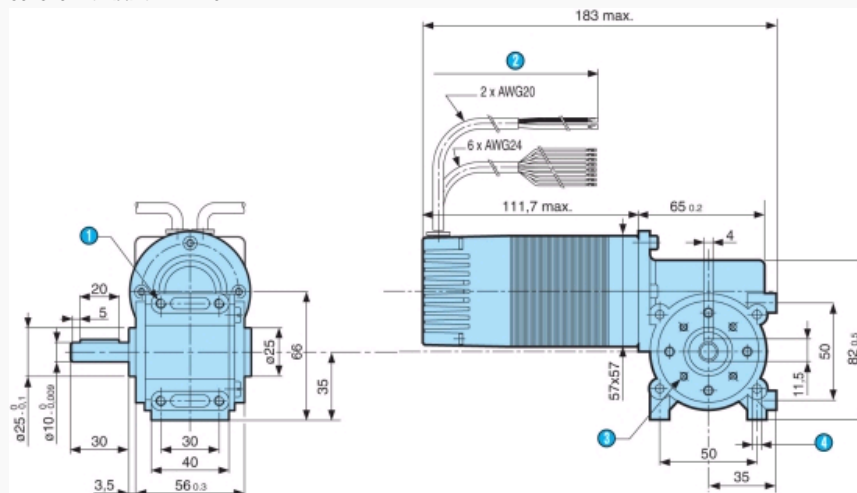

N°	Legend
①	4 x M5 over depth 8 mm
②	Length of cable 500 ± 5 mm
③	4 x M4 over Ø 36 depth 8 mm
④	4 x M5 depth 8 mm

Precautions for use

The limits and precautions for use described in the 80 W brushless motor section must be observed.

Continuous use may cause the gearbox to overheat.

This geared motor is recommended for applications in which the operating time does not exceed 50 % of the total time. For longer times, please consult us.

Product adaptations



- 2-quadrant speed regulation
- With built-in electronic card TNi20
- No lead output but connector in motor
- Dimensions of gearbox shaft
- Cable length, with or without connector
- Other reduction ratios
- Other windings
- Mechanical holding brake