

Subminiature

→ V4

- Nominal ratings 0.1 A to 10 A/250 VAC
- Minimum rating 1 mA/4 VDC
- Operating temperature up to +125°C
- Conforming to standards EN 61058 and UL 1054
- Choice of actuators with 2 possible fixing positions



Main specifications

		Standard 83 170 0	Low force 83 170 4	Dual-current 83 170 8	Dual-current low force 83 170 9
Function	Connections				
I (changeover)	W2	83 170 002	●	83 170 802	●
I (changeover)	W7A5	83 170 005	●	83 170 805	●
I (changeover)	X1	83 170 008	●	83 170 808	●
I (changeover)	X1S - X2 - X2S - X3 - X3S	●	●	●	●
R (normally closed)	W2 - W7A5	●	●	●	●
C (normally open)	W2 - W7A5	●	●	●	●
Electrical characteristics					
Rating nominal / 250 V AC (A)		10	5	0.1	0.1
Rating thermal / 250 V AC (A)		12.5	6	6	6
Mechanical characteristics					
Maximum operating force (N)		1.5	0.6	1.5	0.6
Min. Release force (N)		0.3	0.1	0.3	0.1
Maximum total travel force (N)		1.8	1	1.8	1
Max. permitted overtravel force (N)		10	10	10	10
Rest position max. (mm)		9.2	9.2	9.2	9.2
Tripping point (mm)		8.4 ^{±0.3}	8.4 ^{±0.3}	8.4 ^{±0.3}	8.4 ^{±0.3}
Maximum differential travel (mm)		0.15	0.15	0.15	0.15
Min. overtravel (mm)		0.5	0.5	0.5	0.5
Ambient operating temperature (°C)		-20 → +125	-20 → +125	-20 → +125	-20 → +125
Mechanical life (operations)		10 ^{7*}	3.10 ⁷	10 ⁶	3.10 ⁷
Contact gap (mm)		0.4	0.4	0.4	0.4
Weight (g)		1.7	1.7	1.7	1.7
Comments					

* For 2/3 of the overtravel

Additional specifications

Components

Material

- Case : polyester UL 94 VO
- Button : Glass-filled polyamide
- Contacts : AgNi, gold-plated AgNi (dual-current)
- Terminals : cupro-nickel (except W7A5 in brass)

Levers

- Flat : stainless steel
- Roller : stainless steel, polyamide roller

Approvals

NF - UL - cUL

Product adaptations



- Special levers
- Special connections

To order, see page 12

Principles

Single break changeover switch

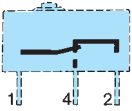

Curves

Operating curve for type 83 170 0

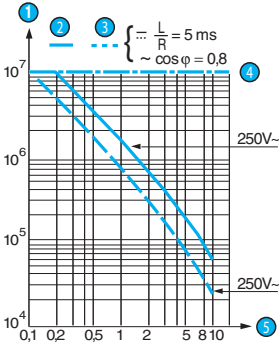

Operating curve for type 83 170 4

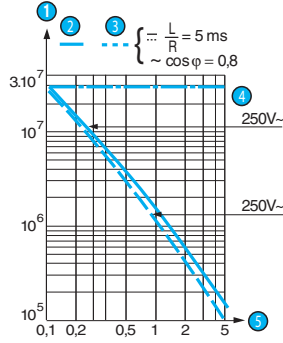

Operating curve for types 83 170 8/83 170 9

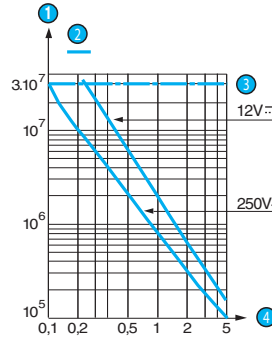

- 1 Number of cycles
- 2 Resistive circuit
- 3 Inductive circuit
- 4 Mechanical life limit
- 5 Current in Amps

- 1 Number of cycles
- 2 Resistive circuit
- 3 Inductive circuit
- 4 Mechanical life limit
- 5 Current in Amps

- 1 Number of cycles
- 2 Resistive circuit
- 3 Mechanical life limit
- 4 Current in Amps

Models 83 170 8 and 83 170 9 are designed to operate equally well on dual-current (1 mA 4 V minimum) or medium-current (5 A maximum) circuits. However, a given product should only be used to switch one type of circuit during its working life.

Dimensions

→ Product

83 170
Asymmetrical version

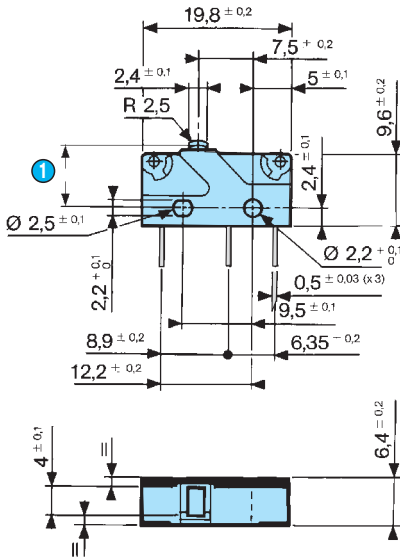

1 OL = 7.6

Fixing with M2 screws
Recommended tightening torque : 2 cm daN

83 170 Symmetrical version

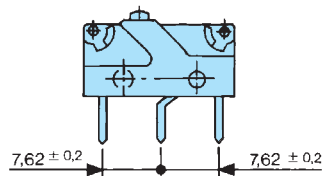

→ Connections

W2

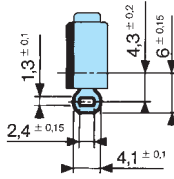

X2 - X2S

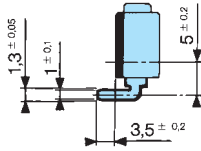

W7A5

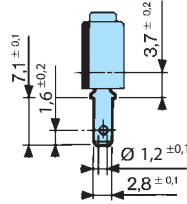

X3 - X3S

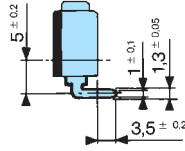

X1 - X1S

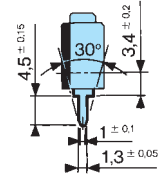

→ Drilling

Printed circuit board mounting
Asymmetrical X1 - X2 - X3

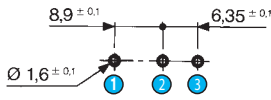

- 1 1.C
- 2 4.NO
- 3 2.NC

Mounting on a printed circuit board
with fixing pins
Asymmetrical

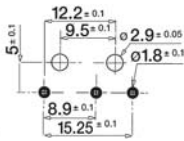

Printed circuit board mounting
Symmetrical X1S - X2S - X3S

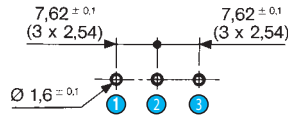

- 1 1.C
- 2 4.NO
- 3 2.NC

Mounting on a printed circuit board
with fixing pins
Symmetrical

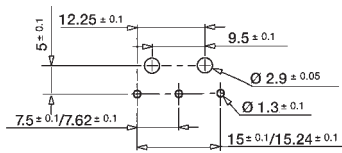

→ Actuator mounting positions

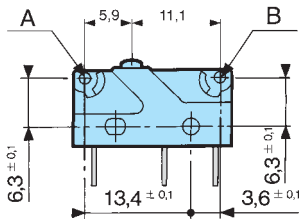

Fixing position

Except where otherwise indicated, levers are supplied unmounted.

For factory mounting, specify fixing position A or B.

To calculate force : divide the switch force by the coefficient in the table.

To calculate travel : multiply the switch travel by the same coefficient.

→ Actuators

170A

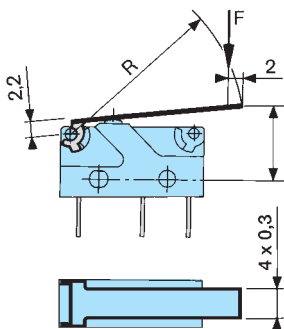

170E

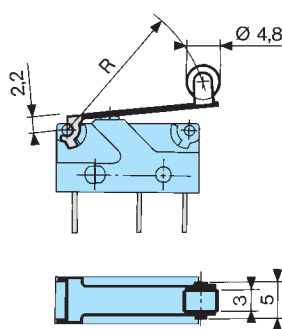

170F

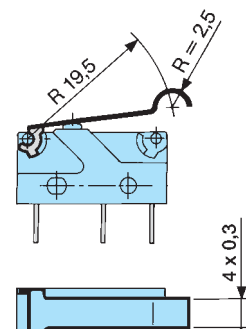

→ Mounting accessories

Fixing pins

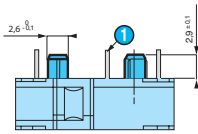



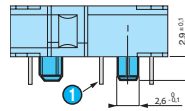

1 Output on unit side : X2

Fixing pins



1 Output on cover side : X3

Actuators and fixing positions

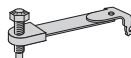
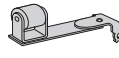
Part numbers for standard actuators	79 253 327		79 253 326		79 253 328		79 218 454		79 253 329	
Actuators	Flat 170A R18.3		Flat 170A F24		Flat 170A R41		Roller 170E R20		Dummy roller 170F	
										
Fixing positions										
Coefficient	A	B	A	B	A	B	A	B	A	B
Tripping point	3	1.5	4	2	7	3.5	3	1.5	3	1.5
	10 \pm 1.4	9.2 \pm 0.9	10.7 \pm 1.7	9.6 \pm 1	12.7 \pm 3	10.6 \pm 1.8	15.5 \pm 1.4	14.5 \pm 0.9	12.9 \pm 1.5	11.9 \pm 1.1
Levers	Screw 170D		Transverse roller 170EL							
										
Characteristics available on request										

Other information

Mounting - Operation

See basic technical concepts