

YG12U13-2550K4051A

**SICK**  
Sensor Intelligence.



## Ordering information

Type	Part no.
YG12U13-2550K4051A	2109296

Other models and accessories → [www.sick.com/](http://www.sick.com/)



## Detailed technical data

### Technical specifications

<b>Accessory group</b>	Plug connectors and cables
<b>Accessory family</b>	Field-attachable connectors
<b>Connection type head A</b>	Female connector, M12, 3-pin, angled, A-coded
<b>Connection type</b>	IDC quick connection
<b>Locking plug connector</b>	Screw connection
<b>Connector material</b>	TPU
<b>Connector color</b>	Black
<b>Locking nut material</b>	Zinc die-cast, nickel-plated
<b>Seal material</b>	FKM / PUR
<b>Tightening torque</b>	0.6 Nm
<b>Width across flats</b>	13
<b>Permitted cable diameter</b>	4 mm ... 5.1 mm
<b>Permitted cross-section</b>	0.25 mm <sup>2</sup> ... 0.5 mm <sup>2</sup>
<b>Reference voltage</b>	≤ 32 V DC
<b>Rated impulse voltage</b>	0.8 kV
<b>Current loading</b>	4 A
<b>Signal type</b>	Sensor/actuator cable
<b>Authorizations</b>	CE
<b>Enclosure rating</b>	IP67
<b>Ambient operating temperature</b>	
	Head -25 °C ... +85 °C
<b>Contamination rating</b>	3
<b>Insulation resistance</b>	100 MΩ
<b>Overvoltage category</b>	III
<b>Specific insulation resistance</b>	30 mΩ

Dimensional drawing (Dimensions in mm (inch))

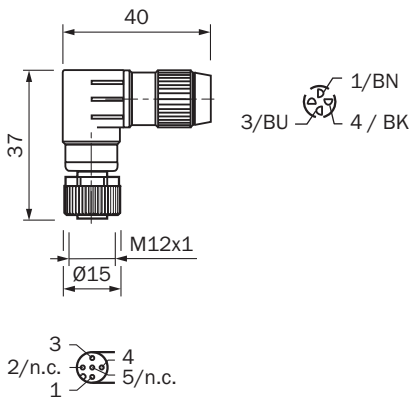

## SICK AT A GLANCE

SICK is one of the leading manufacturers of intelligent sensors and sensor solutions for industrial applications. A unique range of products and services creates the perfect basis for controlling processes securely and efficiently, protecting individuals from accidents and preventing damage to the environment.

We have extensive experience in a wide range of industries and understand their processes and requirements. With intelligent sensors, we can deliver exactly what our customers need. In application centers in Europe, Asia and North America, system solutions are tested and optimized in accordance with customer specifications. All this makes us a reliable supplier and development partner.

Comprehensive services complete our offering: SICK LifeTime Services provide support throughout the machine life cycle and ensure safety and productivity.

For us, that is “Sensor Intelligence.”

## WORLDWIDE PRESENCE:

Contacts and other locations –[www.sick.com](http://www.sick.com)